

RAZ - CUSTOM SEAT ASSESSMENT FORM



Client: _____ Chair Model: AP/SP AT CAT AP/SP600 AT600

Reference #: _____ Serial #: _____

Access Opening: Select one if applicable

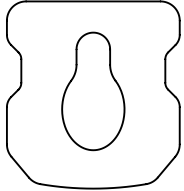

Bridged Front

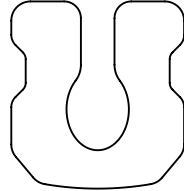

Front Open

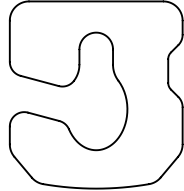

Left Open

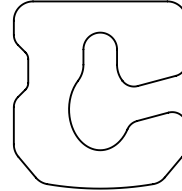

Right Open

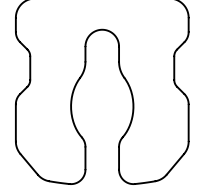

Rear Open

Aperture Shape: Select one

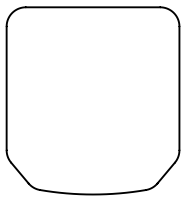

No Aperture

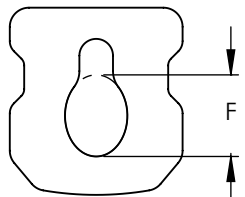

Keyhole - Standard

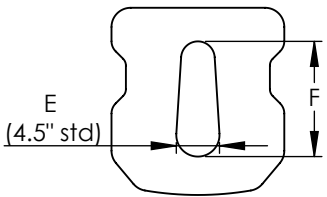

CAT - Style

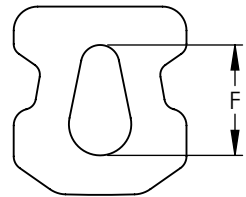

EJR - Style

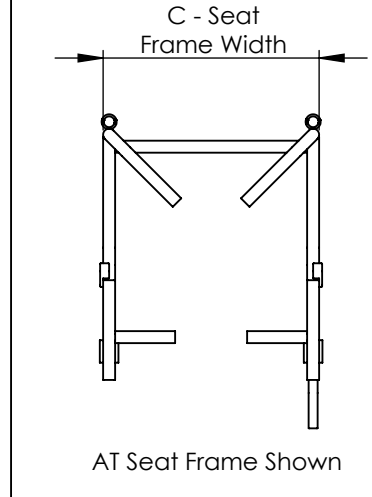
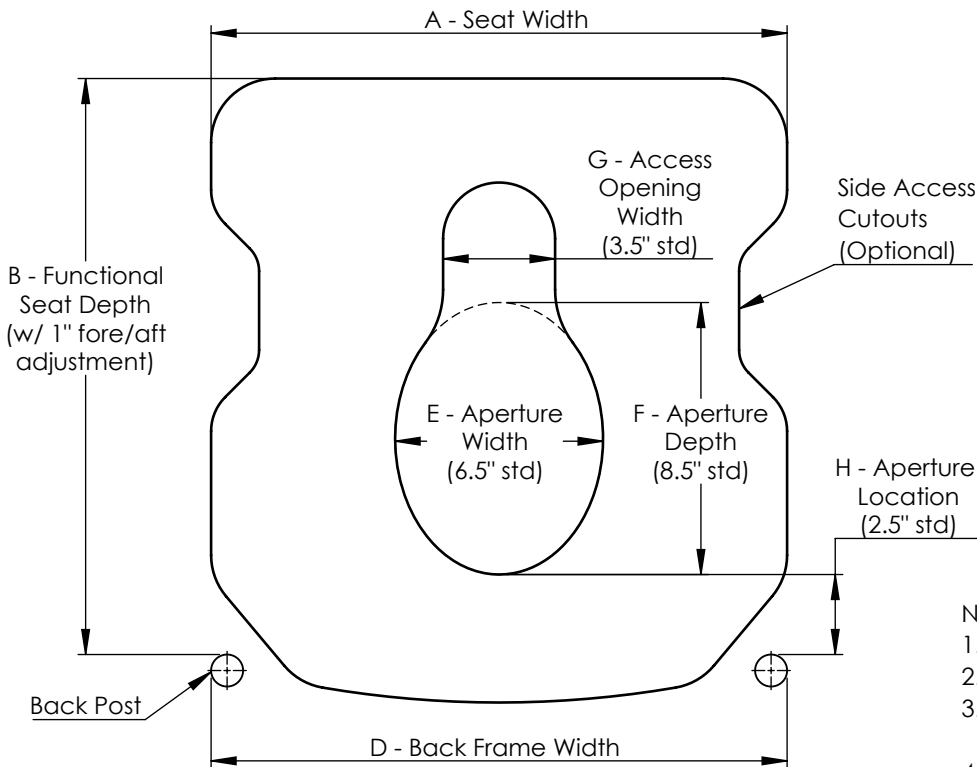

Notes:

1. Keyhole Style Aperture Shown
2. Specify Units (Inch mm)
3. Seat width can be up to 2" wider than seat frame
4. Call for other customization options

A	Seat Width:	E	Aperture Width:
B	Seat Depth:	F	Aperture Depth:
C	Seat Frame Width:	G	Opening Width:
D	Back Frame Width:	H	Aperture Location:

Comments: